

- NOTES:**
 1. BEARING IS PACKED WITH GREASE
 2. ALL EXPOSED SURFACES ARE BLACK OXIDED

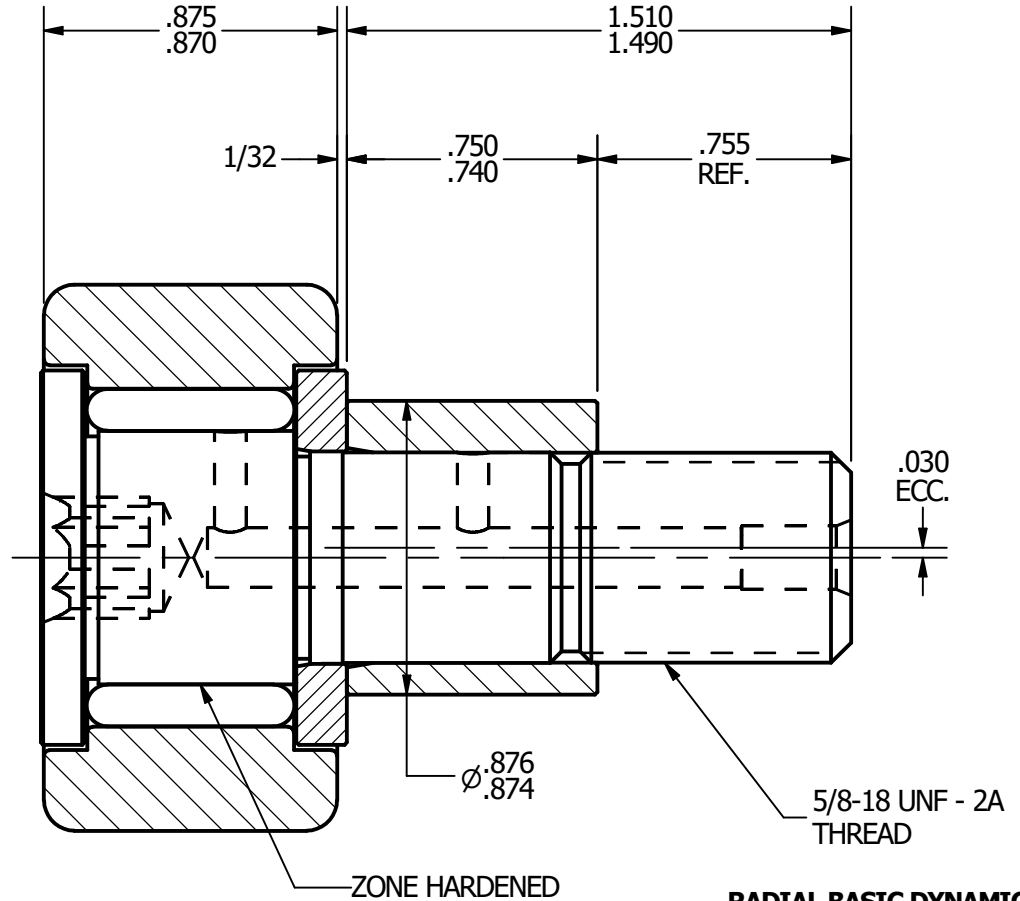
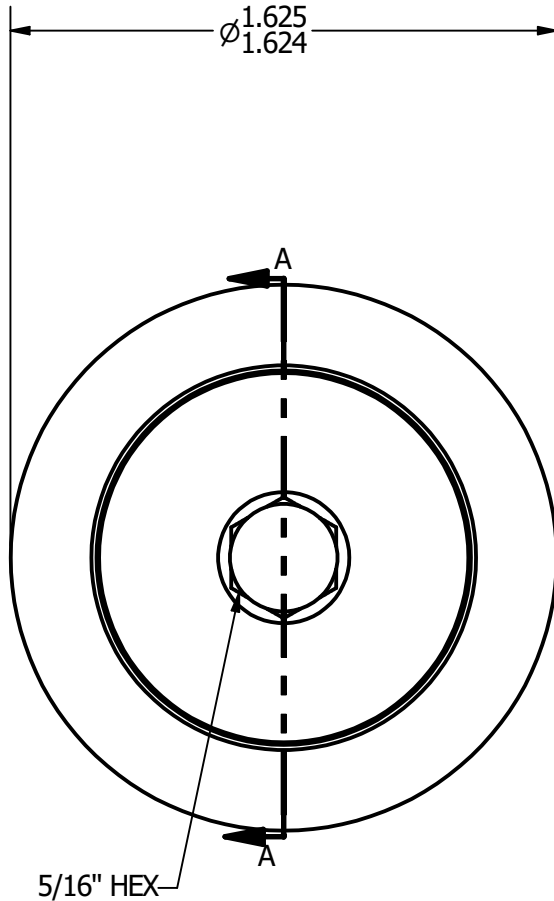
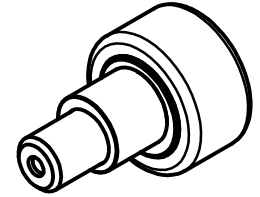

RADIAL BASIC DYNAMIC RATING (POUNDS) 4,840

MAXIMUM STATIC CAPACITY (POUNDS) 5,640

MATERIAL NOTES:

- OUTER - BEARING STEEL, HEAT TREATED**
- STUD - BEARING STEEL, ZONE HARDENED**
- ROLLER - BEARING STEEL, HEAT TREATED**
- WASHER - COLD ROLLED STEEL, HEAT TREATED**
- ECCENTRIC SLEEVE - COLD ROLLED STEEL**

CUSTOMER PART#

.XX = ± .01
 .XXX = ± .005
 .XXXX = ± .0005
 ANGLES = ± 1°
 INCH [METRIC]

CARTER MANUFACTURING IS NOT RESPONSIBLE FOR TYPOGRAPHICAL ERRORS

CARTER MANUFACTURING CO., INC.

GRAND HAVEN, MICHIGAN 49417

REVISION

PART NAME: Assembly

SHEET 1 OF 2

CHANGE NOTE:

A

REV. BY

AUTHOR. BY

DRAWN BY

CHK'D BY

SALES

MATERIAL

JGV

JAF

JGV

KPR

NOTED

DATE

DATE

DATE

DATE

DRAWING NO.

7/14/2006

7/14/2006

7/14/2006

7/13/2006

CNBE-52-B